



Company: Empresas Suarez S.A. de C.V.

Name:

Date: 8/4/2017

Pump:

Size: 8WL-1A (1 stage)
 Type: LINEA SEMI-ABIERTA
 Synch speed: 1800 rpm
 Curve: ETWBDED
 Specific Speeds:
 Dimensions:
 Vertical Turbine:
 Speed: 1760 rpm
 Dia: 5.25 in
 Impeller: 8WL-1A
 Ns: 2558
 Nss: 1915
 Suction: 6"
 Discharge: RI 4" RI 6"
 Bowl size: 7.5 in
 Max lateral: ---
 Thrust K factor: 5.3 lb/ft

Search Criteria:

Flow: --- Head: ---

Fluid:

Water
 SG: 1
 Viscosity: 0.9946 cP
 NPSHa: ---
 Temperature: 68 °F
 Vapor pressure: 0.3391 psi a
 Atm pressure: 14.7 psi a

Motor:

Standard: NEMA
 Enclosure: TEFC
 Sizing criteria: Max Power on Design Curve
 Size: 2 hp
 Speed: 1800
 Frame: 145T

Pump Limits:

Temperature: 167 °F
 Pressure: 425 psi g
 Sphere size: 0.375 in
 Power: 60 hp
 Eye area: 8.5 in²

---- Data Point ----

Flow: 245 US gpm
 Head: 23.3 ft
 Eff: 81%
 Power: 1.78 hp
 NPSHr: 5.05 ft

---- Design Curve ----

Shutoff head: 32.7 ft
 Shutoff dP: 14.1 psi
 Min flow: 50 US gpm
 BEP: 81% @ 245 US gpm
 NOL power:
 1.88 hp @ 323 US gpm

-- Max Curve --

Max power:
 1.88 hp @ 323 US gpm

--Additional Data--

Std. Shaft Diameter :1.19
 Max. Shaft Diameter: C.F.
 Opt. Lateral Setting: 0.02
 Std. Lateral:0.35
 One Stage Subm. WT-LB:N/A
 One Stage Water Lub. WT-LB:72.6
 One Stage Oil Lub. WT-LB:81.6
 Add Stage WT-LB:32.2
 Impeller Weight:4.2 lb
 Min. Submergence:16

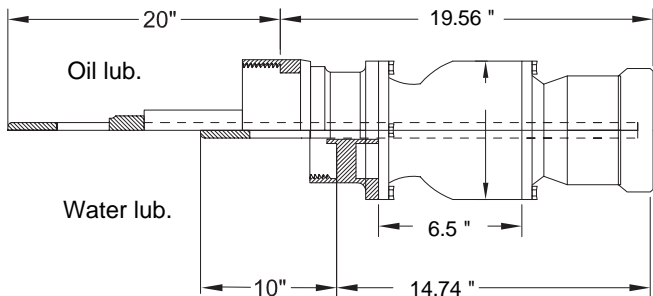
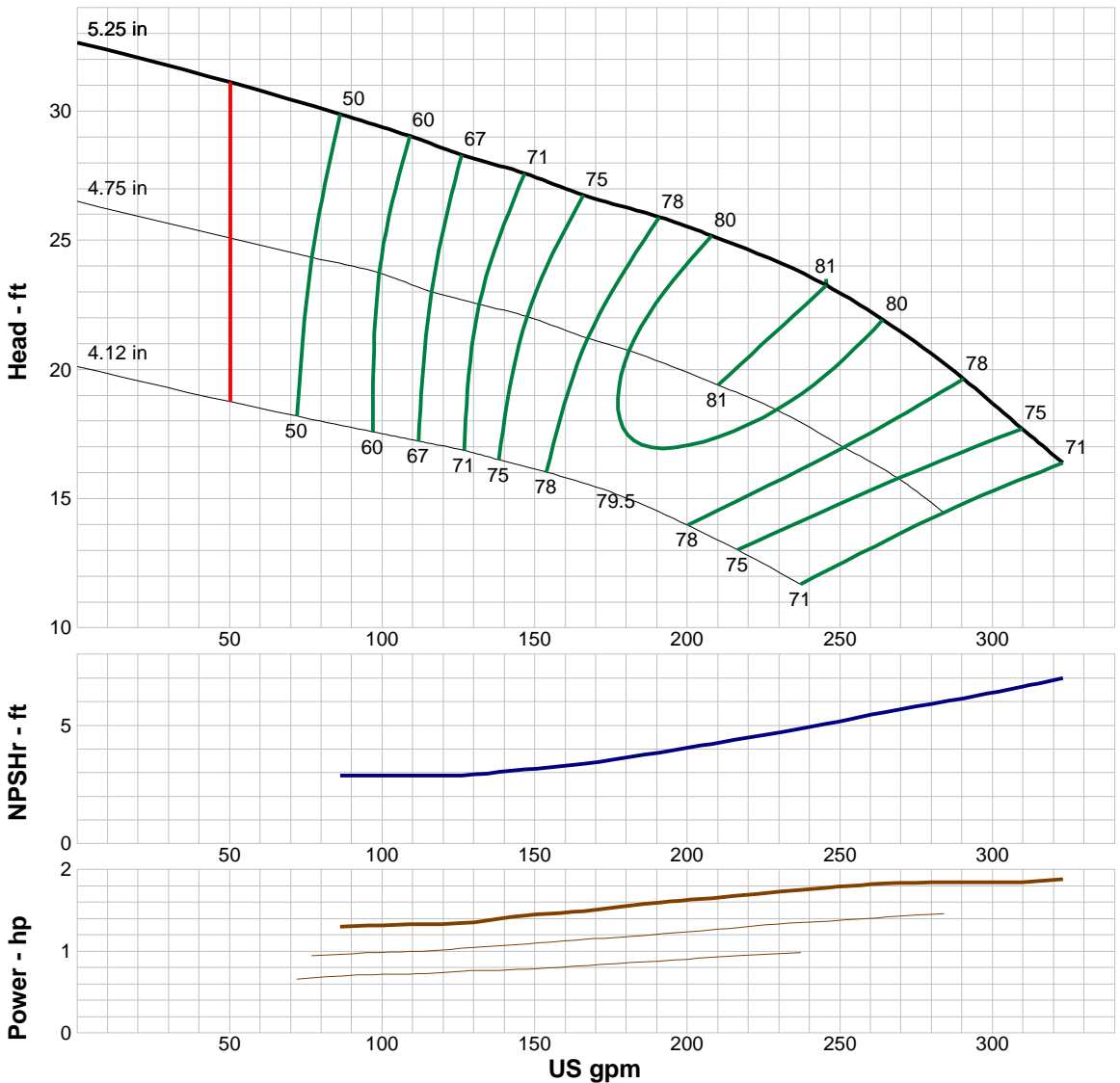

Performance Evaluation:

Flow US gpm	Speed rpm	Head ft	Efficiency %	Power hp	NPSHr ft
310	1760	17.7	74.8	1.85	6.64
258	1760	22.4	80.3	1.81	5.39
206	1760	25.3	79.8	1.65	4.18
155	1760	27.2	72.8	1.46	3.24
103	1760	29.3	57.4	1.32	2.89



Company: Empresas Suarez S.A. de C.V.

Name:

Date: 8/3/2017

Pump:

Size: 8WH-1A (1 stage)
 Type: LINEA SEMI-ABIERTA
 Synch speed: 1800 rpm
 Curve: ETWBEEB
 Specific Speeds:
 Dimensions:
 Vertical Turbine:
 Speed: 1760 rpm
 Dia: 5.25 in
 Impeller: 8WH-1A
 Ns: 2916
 Nss: 2374
 Suction: 6"
 Discharge: RI 4" RI 6"
 Bowl size: 7.5 in
 Max lateral: ---
 Thrust K factor: 5.3 lb/ft

Search Criteria:

Flow: --- Head: ---

Fluid:

Water
 SG: 1
 Viscosity: 0.9946 cP
 NPSHa: ---
 Temperature: 68 °F
 Vapor pressure: 0.3391 psi a
 Atm pressure: 14.7 psi a

Motor:

Standard: NEMA
 Enclosure: TEFC
 Sizing criteria: Max Power on Design Curve
 Size: 3 hp
 Speed: 1800
 Frame: 182T

Pump Limits:

Temperature: 167 °F
 Pressure: 425 psi g
 Sphere size: 0.375 in
 Power: 83 hp
 Eye area: 8.5 in²

---- Data Point ----

Flow: 328 US gpm
 Head: 24.1 ft
 Eff: 81.5%
 Power: 2.45 hp
 NPSHr: 8.34 ft

---- Design Curve ----

Shutoff head: 29.5 ft
 Shutoff dP: 12.7 psi
 Min flow: 67 US gpm
 BEP: 81.5% @ 328 US gpm
 NOL power:
 2.75 hp @ 451 US gpm

-- Max Curve --

Max power:
 2.75 hp @ 451 US gpm

--Additional Data--

Std. Shaft Diameter :1.19
 Max. Shaft Diameter: C.F.
 Opt. Lateral Setting: 0.02
 Std. Lateral:0.35
 One Stage Subm. WT-LB:N/A
 One Stage Water Lub. WT-LB:72.6
 One Stage Oil Lub. WT-LB:81.6
 Add Stage WT-LB:32.2
 Impeller Weight: 4.2 lb
 Min. Submergence: 16

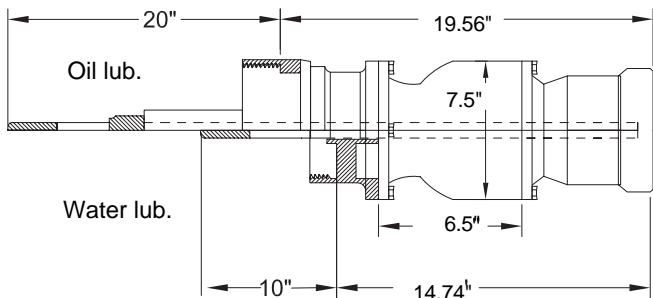
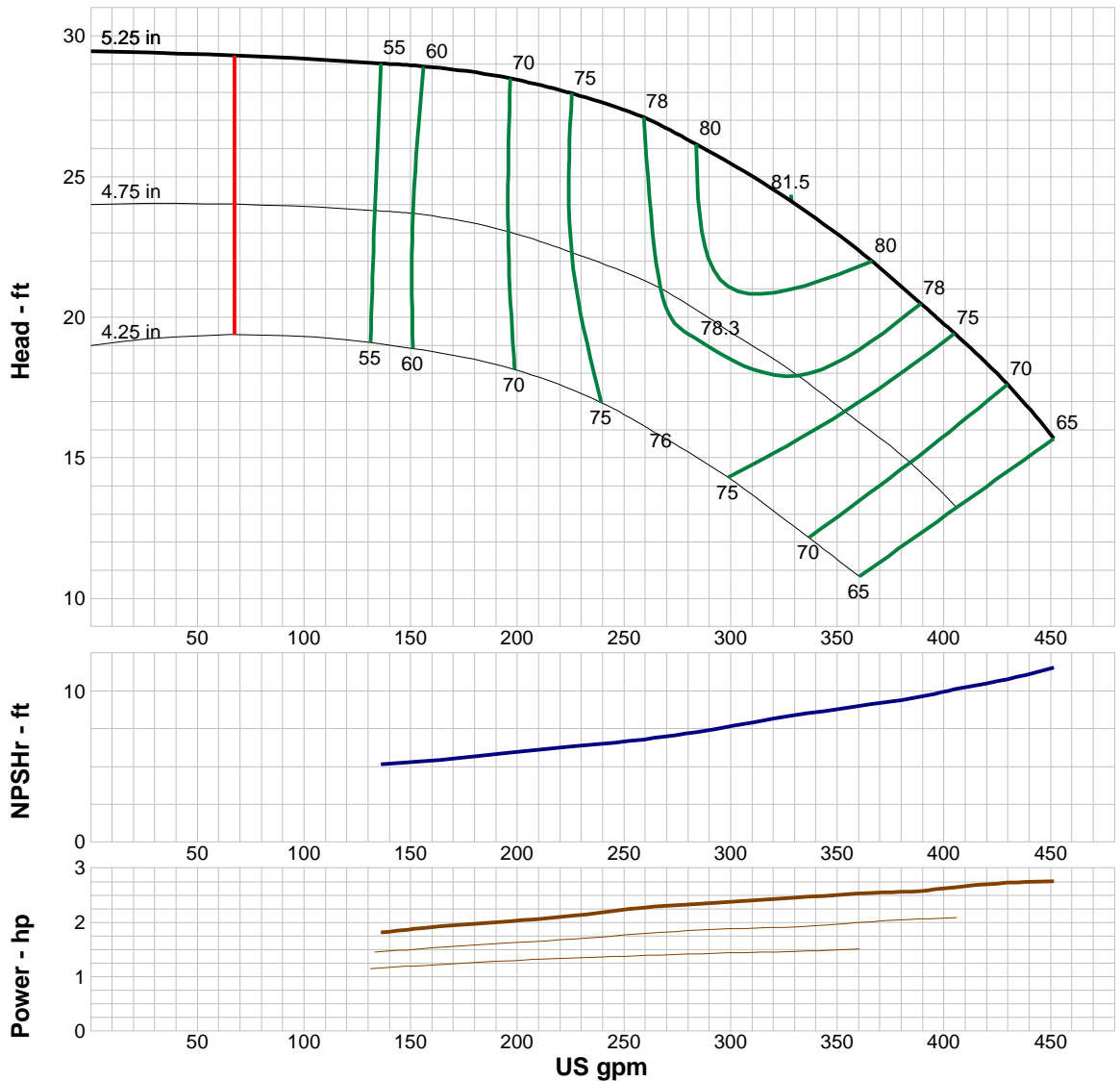

Performance Evaluation:

Flow US gpm	Speed rpm	Head ft	Efficiency %	Power hp	NPSHr ft
433	1760	17.3	69.2	2.73	10.9
361	1760	22.3	80.2	2.53	9.02
289	1760	25.9	80.2	2.35	7.41
217	1760	28.1	73.6	2.09	6.2
144	1760	29	57	1.85	5.22



Company: Empresas Suarez S.A. de C.V.

Name:

Date: 8/4/2017

Pump:

Size: 9WL-1A (1 stage)
 Type: LINEA SEMI-ABIERTA
 Synch speed: 1800 rpm
 Curve: ETWBDEE
 Specific Speeds:
 Dimensions:
 Vertical Turbine:
 Speed: 1770 rpm
 Dia: 6.88 in
 Impeller: 9WL-1A
 Ns: 2579
 Nss: 2027
 Suction: 8"
 Discharge: RI 6" RI 8"
 Bowl size: 9.3 in
 Max lateral: ---
 Thrust K factor: 6 lb/ft

Search Criteria:

Flow: --- Head: ---

Fluid:

Water
 SG: 1
 Viscosity: 0.9946 cP
 NPSHa: ---
 Temperature: 68 °F
 Vapor pressure: 0.3391 psi a
 Atm pressure: 14.7 psi a

Motor:

Standard: NEMA
 Enclosure: TEFC
 Sizing criteria: Max Power on Design Curve
 Size: 7.5 hp
 Speed: 1800
 Frame: 213T

Pump Limits:

Temperature: 167 °F
 Pressure: 400 psi g
 Sphere size: 0.5 in
 Power: 84 hp
 Eye area: 12.6 in²

---- Data Point ----	
Flow:	439 US gpm
Head:	40 ft
Eff:	85.3%
Power:	5.2 hp
NPSHr:	6.18 ft
---- Design Curve ----	
Shutoff head:	52.6 ft
Shutoff dP:	22.8 psi
Min flow:	96 US gpm
BEP:	85.3% @ 439 US gpm
NOL power:	5.29 hp @ 547 US gpm
-- Max Curve --	
Max power:	5.29 hp @ 547 US gpm
--Additional Data--	
Std. Shaft Diameter :	1.5"
Max. Shaft Diameter:	C.F.
Opt. Lateral Setting:	0.02
Std. Lateral:	0.53
One Stage Subm. WT-LB:	N/A
One Stage Water Lub. WT-LB:	143.1
One Stage Oil Lub. WT-LB:	165.1
Add Stage WT-LB:	62
Impeller Weight:	7.1 lb
Min. Submergence:	62

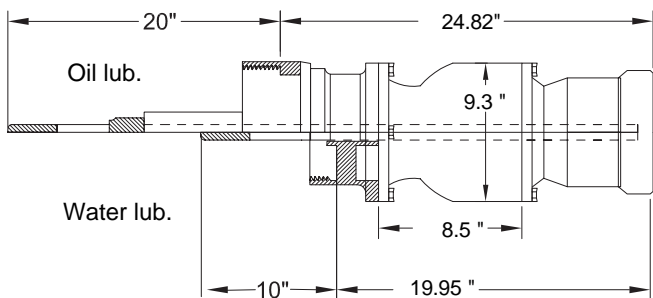
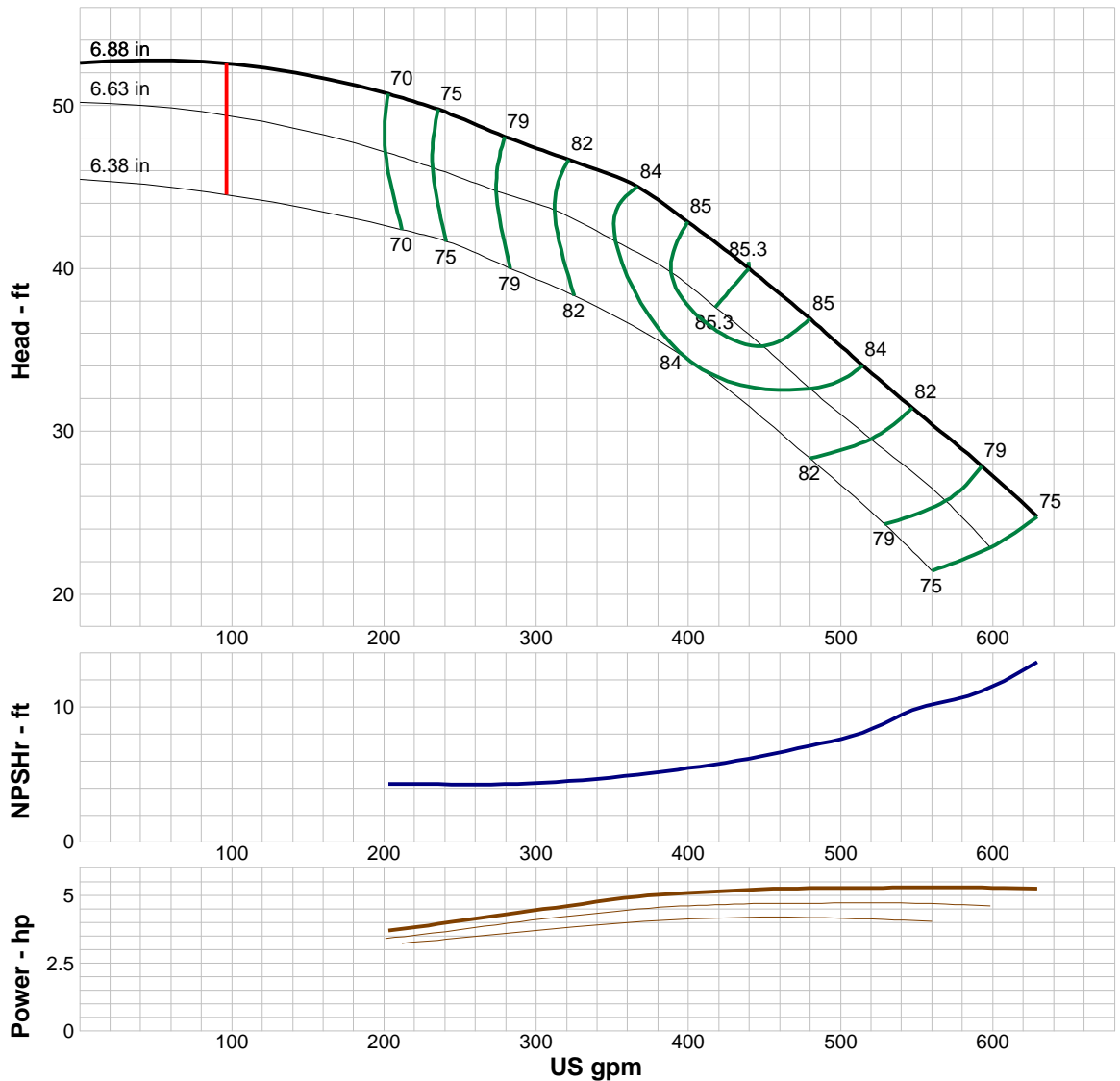

Performance Evaluation:

Flow US gpm	Speed rpm	Head ft	Efficiency %	Power hp	NPSHr ft
604	1770	26.9	77.7	5.27	11.9
503	1770	35	84.3	5.26	7.79
402	1770	42.7	85	5.09	5.53
302	1770	47.3	80.7	4.47	4.42
201	1770	50.7	69.8	3.69	4.29



Company: Empresas Suarez S.A. de C.V.

Name:

Date: 8/3/2017

Pump:

Size: 9WH-1A (1 stage)
 Type: LINEA SEMI-ABIERTA
 Synch speed: 1800 rpm
 Curve: ETWBEEE
 Specific Speeds:
 Dimensions:
 Vertical Turbine:
 Speed: 1770 rpm
 Dia: 6.88 in
 Impeller: 9WH-1A
 Ns: 2573
 Nss: 1966
 Suction: 8"
 Discharge: RI 6" RI 8"
 Bowl size: 9.3 in
 Max lateral: ---
 Thrust K factor: 6 lb/ft

Search Criteria:

Flow: --- Head: ---

Fluid:

Water
 SG: 1
 Viscosity: 0.9946 cP
 NPSHa: ---
 Temperature: 68 °F
 Vapor pressure: 0.3391 psi a
 Atm pressure: 14.7 psi a

Motor:

Standard: NEMA
 Enclosure: TEFC
 Sizing criteria: Max Power on Design Curve
 Size: 10 hp
 Speed: 1800
 Frame: 215T

Pump Limits:

Temperature: 167 °F
 Pressure: 400 psi g
 Sphere size: 0.5 in
 Power: 115 hp
 Eye area: 12.6 in²

---- Data Point ----	
Flow:	529 US gpm
Head:	48 ft
Eff:	85.3%
Power:	7.52 hp
NPSHr:	10.2 ft
---- Design Curve ----	
Shutoff head:	55 ft
Shutoff dP:	23.8 psi
Min flow:	115 US gpm
BEP:	85.3% @ 529 US gpm
NOL power:	8.48 hp @ 762 US gpm
-- Max Curve --	
Max power:	8.48 hp @ 762 US gpm
--Additional Data--	
Std. Shaft Diameter :	1.5"
Max. Shaft Diameter:	C.F.
Opt. Lateral Setting:	0.02
Std. Lateral:	0.53
One Stage Subm. WT-LB:	N/A
One Stage Water Lub. WT-LB:	143.1
One Stage Oil Lub. WT-LB:	165.1
Add Stage WT-LB:	62
Impeller Weight:	7.1lb
Min. Submergence:	19

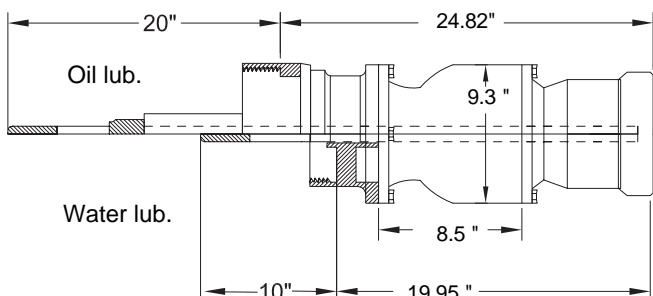
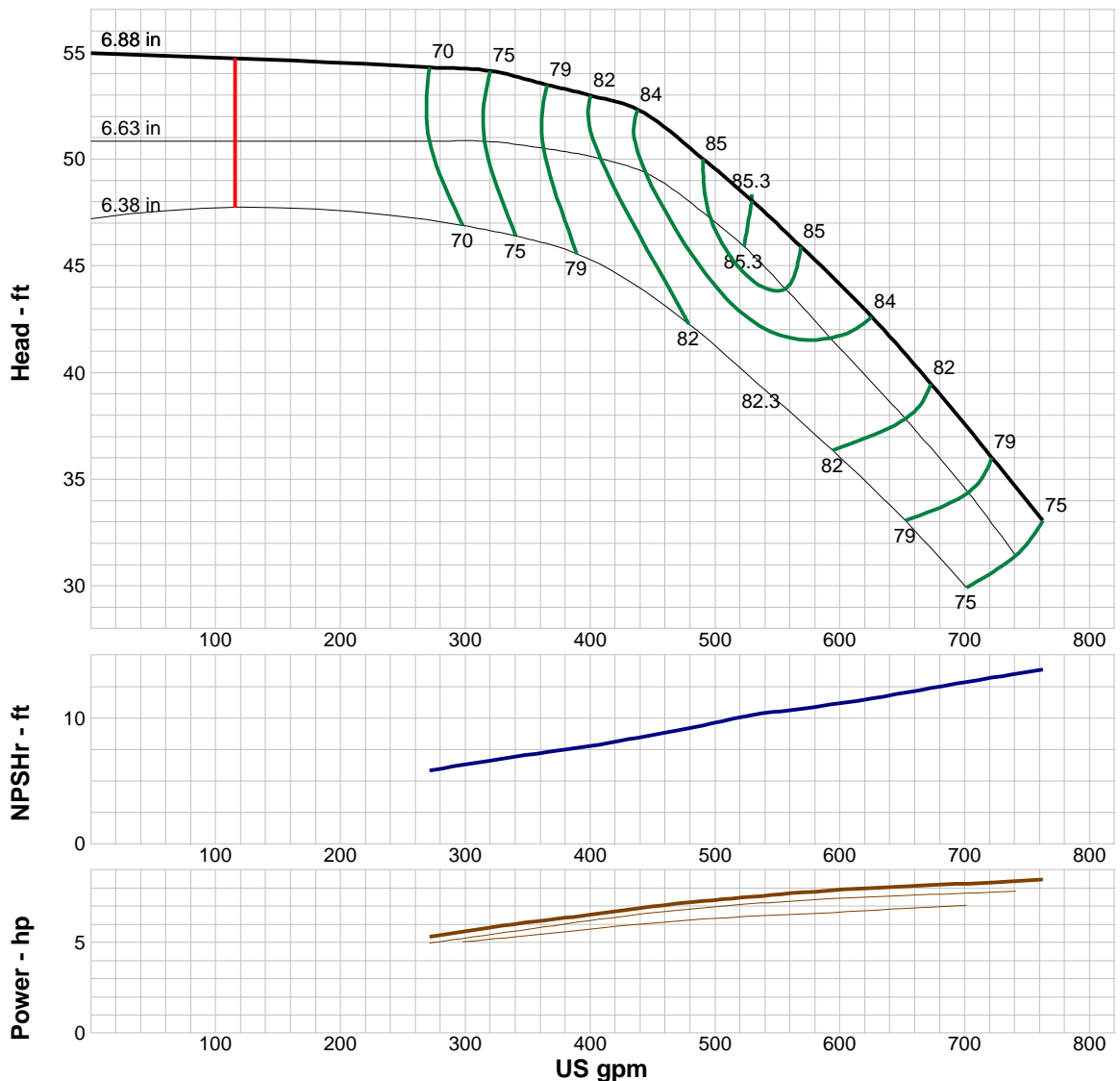

Performance Evaluation:

Flow US gpm	Speed rpm	Head ft	Efficiency %	Power hp	NPSHr ft
732	1770	35.2	78	8.35	13.4
610	1770	43.5	84.3	7.94	11.3
488	1770	50.1	85	7.26	9.39
366	1770	53.5	79.1	6.25	7.3
244	1770	54.4	67.2	5.02	5.37



Company: Empresas Suarez S.A. de C.V.

Name:

Date: 8/7/2017

Pump:

Size: 10HXH-1A (1 stage)
 Type: LINEA SEMI-ABIERTA
 Synch speed: 1800 rpm
 Curve: ETXBDEF
 Specific Speeds:
 Dimensions:
 Vertical Turbine:
 Speed: 1760 rpm
 Dia: 8.25 in
 Impeller: 10HXH-1A
 Ns: 3808
 Nss: 6961
 Suction: 8"
 Discharge: RI 8"
 Bowl size: 9.6 in
 Max lateral: ---
 Thrust K factor: 11.4 lb/ft

Search Criteria:

Flow: --- Head: ---

Fluid:

Water
 SG: 1
 Viscosity: 0.9946 cP
 NPSHa: ---
 Temperature: 68 °F
 Vapor pressure: 0.3391 psi a
 Atm pressure: 14.7 psi a

Motor:

Standard: NEMA
 Enclosure: TEFC
 Sizing criteria: Max Power on Design Curve
 Size: 15 hp
 Speed: 1800
 Frame: 254T

Pump Limits:

Temperature: 167 °F
 Pressure: 455 psi g
 Sphere size: 0.875 in
 Power: 179 hp
 Eye area: 19.4 in²

---- Data Point ----

Flow: 1002 US gpm
 Head: 37.9 ft
 Eff: 80.3%
 Power: 12 hp
 NPSHr: 14 ft

---- Design Curve ----

Shutoff head: 62 ft
 Shutoff dP: 26.8 psi
 Min flow: 207 US gpm
 BEP: 80.3% @ 1002 US gpm
 NOL power:
 12 hp @ 207 US gpm

-- Max Curve --

Max power:
 12 hp @ 207 US gpm

--Additional Data--

Std. Shaft Diameter : 1.5"
 Max. Shaft Diameter: C.F.
 Opt. Lateral Setting: 0.02
 Std. Lateral:0.47
 One Stage Subm. WT-LB:N/A
 One Stage Water Lub. WT-LB:155.6
 One Stage Oil Lub. WT-LB: N/A
 Add Stage WT-LB:162.4
 Impeller Weight: 7.3 lb
 Min. Submergence:28

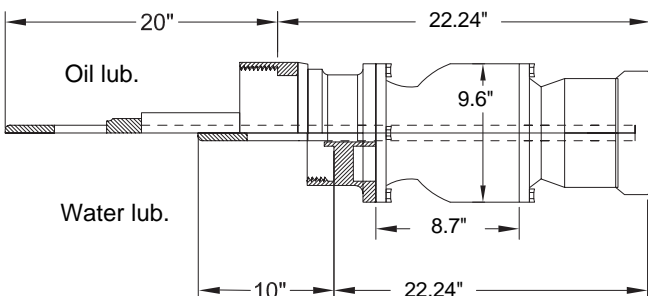
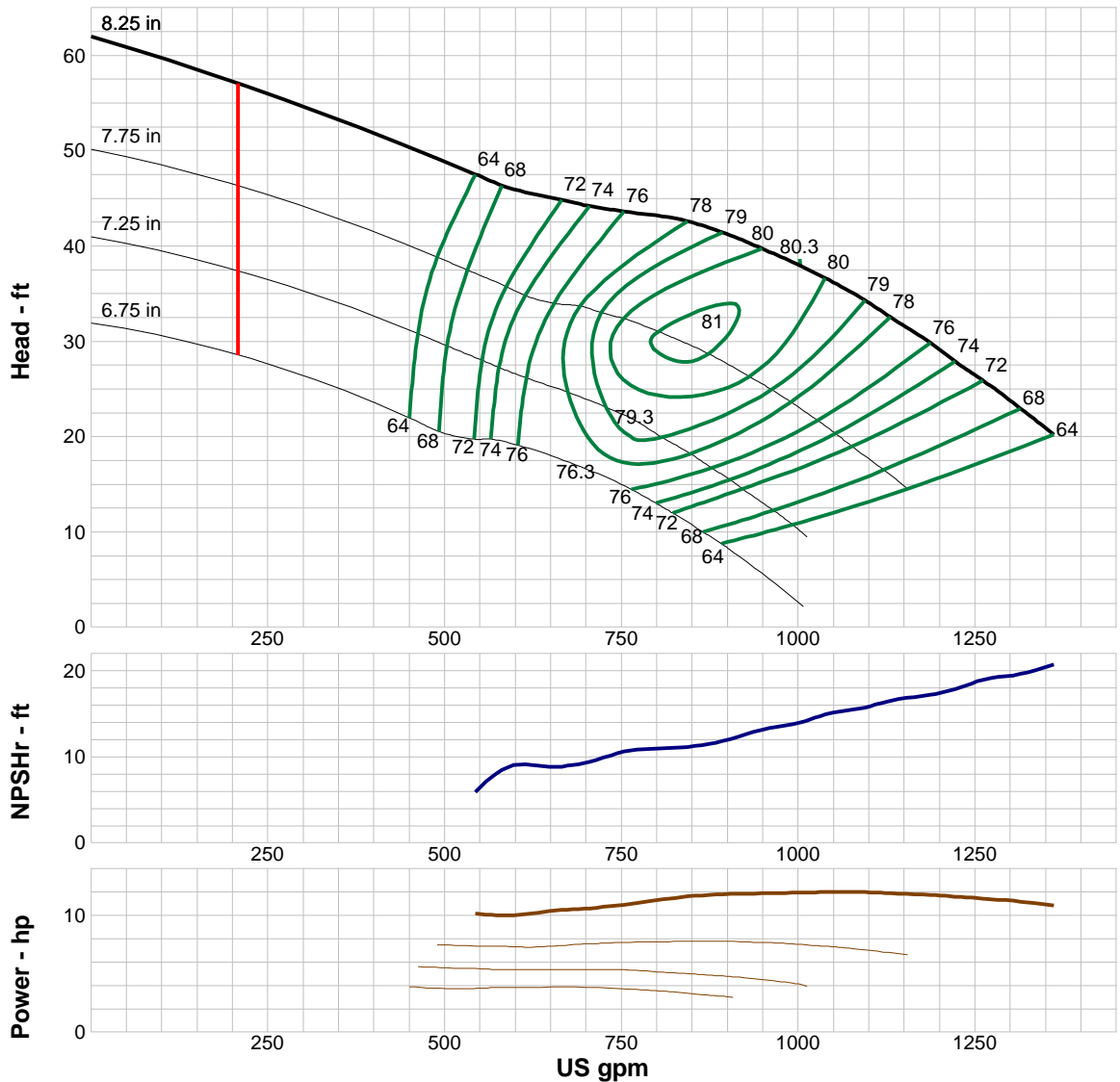

Performance Evaluation:

Flow US gpm	Speed rpm	Head ft	Efficiency %	Power hp	NPSHr ft
1307	1760	23.3	68.5	11.2	19.6
1089	1760	34.5	79.1	12	15.7
871	1760	41.9	78.6	11.7	11.5
653	1760	45.1	71.4	10.4	8.83
436	1760	50.4	52.4	10.8	-1.44



Company: Empresas Suarez S.A. de C.V.

Name:

Date: 8/7/2017

Pump:

Size: 10HH-1A (1 stage)
 Type: LINEA SEMI-ABIERTA
 Synch speed: 1800 rpm
 Curve: ETHBDEF
 Specific Speeds:
 Dimensions:
 Vertical Turbine:
 Speed: 1760 rpm
 Dia: 8.25 in
 Impeller: 10HH-1A
 Ns: 5078
 Nss: 7592
 Suction: 8"
 Discharge: RI 8"
 Bowl size: 9.6 in
 Max lateral: ---
 Thrust K factor: 13.5 lb/ft

Search Criteria:

Flow: --- Head: ---

Fluid:

Water
 SG: 1
 Viscosity: 0.9946 cP
 NPSHa: ---
 Temperature: 68 °F
 Vapor pressure: 0.3391 psi a
 Atm pressure: 14.7 psi a

Motor:

Standard: NEMA
 Enclosure: TEFC
 Sizing criteria: Max Power on Design Curve
 Size: 15 hp
 Speed: 1800
 Frame: 254T

Pump Limits:

Temperature: 167 °F
 Pressure: 455 psi g
 Sphere size: 1.438 in
 Power: 250 hp
 Eye area: 26.7 in²

---- Data Point ----

Flow: 1459 US gpm
 Head: 31.4 ft
 Eff: 83%
 Power: 13.9 hp
 NPSHr: 17 ft

---- Design Curve ----

Shutoff head: 57.1 ft
 Shutoff dP: 24.7 psi
 Min flow: 292 US gpm
 BEP: 83% @ 1459 US gpm
 NOL power:
 14 hp @ 1360 US gpm

-- Max Curve --

Max power:
 14 hp @ 1360 US gpm

--Additional Data--

Std. Shaft Diameter :1.5"
 Max. Shaft Diameter: C.F.
 Opt. Lateral Setting: 0.02
 Std. Lateral:0.54
 One Stage Subm. WT-LB:N/A
 One Stage Water Lub. WT-LB:N/A
 One Stage Oil Lub. WT-LB: 149.2
 Add Stage WT-LB:156
 Impeller Weight:5.8lb
 Min. Submergence:30

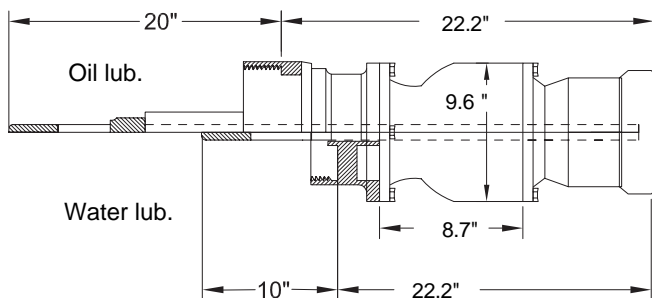
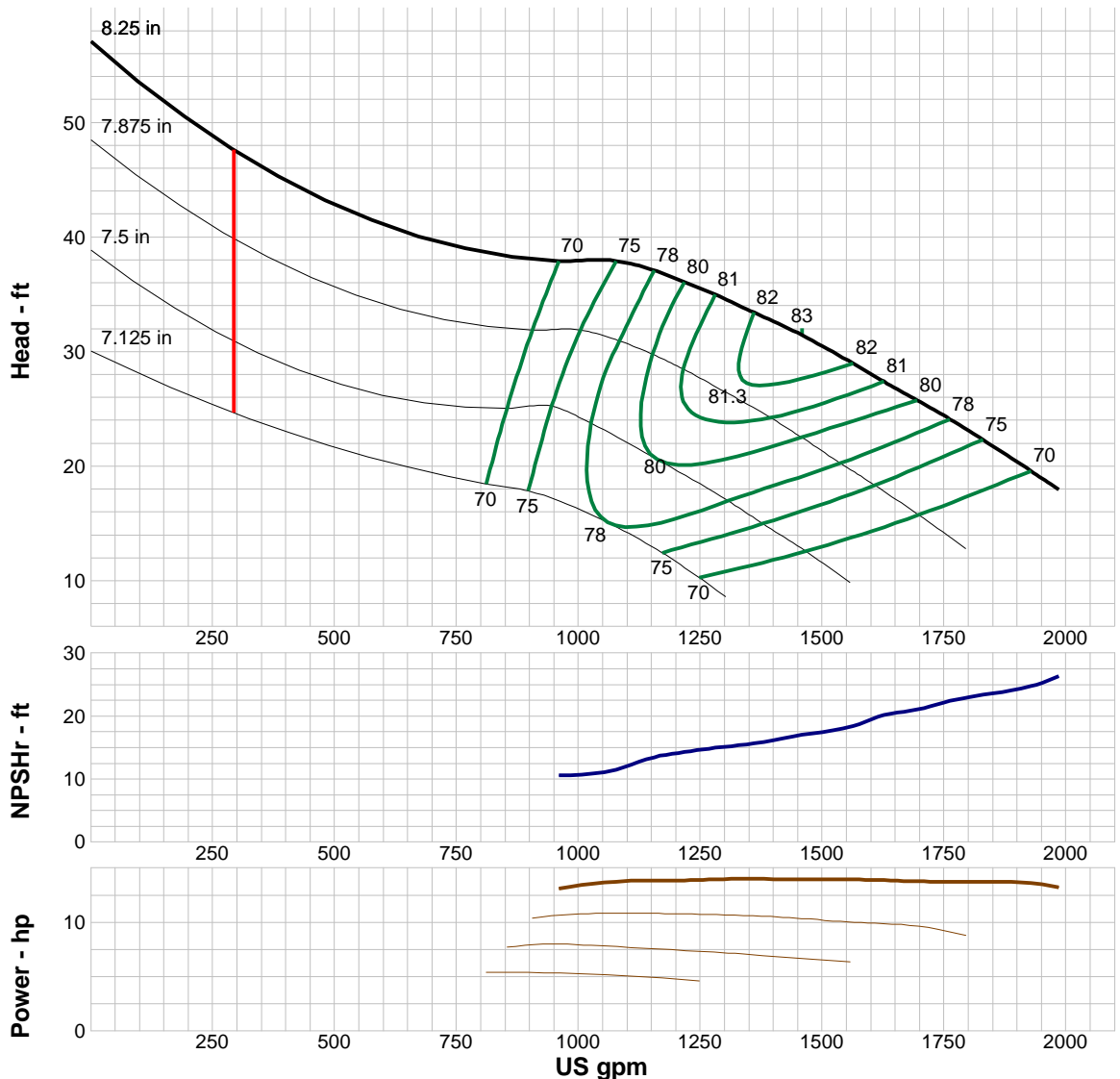

Performance Evaluation:

Flow US gpm	Speed rpm	Head ft	Efficiency %	Power hp	NPSHr ft
1906	1760	20.2	71.1	13.6	24.4
1588	1760	28.3	81.6	13.9	19.1
1270	1760	35.2	80.8	13.9	14.9
953	1760	38	69.7	13.1	10.6
635	1760	44.4	56.1	11.4	8.15



Company: Empresas Suarez S.A. de C.V.

Name:

Date: 8/4/2017

Pump:

Size: 11WL-1A (1 stage)
 Type: LINEA SEMI-ABIERTA
 Synch speed: 1800 rpm
 Curve: ETWBDEG
 Specific Speeds:
 Dimensions:
 Vertical Turbine:
 Speed: 1770 rpm
 Dia: 8.13 in
 Impeller: 11WL-1A
 Ns: 2648
 Nss: 1976
 Suction: 8"
 Discharge: RI 8"RI 10"
 Bowl size: 11 in
 Max lateral: ---
 Thrust K factor: 9.1 lb/ft

Search Criteria:

Flow: --- Head: ---

Fluid:

Water
 SG: 1
 Viscosity: 0.9946 cP
 NPSHa: ---
 Temperature: 68 °F
 Vapor pressure: 0.3391 psi a
 Atm pressure: 14.7 psi a

Motor:

Standard: NEMA
 Enclosure: TEFC
 Sizing criteria: Max Power on Design Curve
 Size: 15 hp
 Speed: 1800
 Frame: 254T

Pump Limits:

Temperature: 167 °F
 Pressure: 380 psi g
 Sphere size: 0.5 in
 Power: 121 hp
 Eye area: 15.6 in²

---- Data Point ----

Flow: 721 US gpm
 Head: 55 ft
 Eff: 84.3%
 Power: 11.9 hp
 NPSHr: 8.41 ft

---- Design Curve ----

Shutoff head: 75.9 ft
 Shutoff dP: 32.8 psi
 Min flow: 159 US gpm
 BEP: 84.3% @ 721 US gpm
 NOL power:
 12.1 hp @ 852 US gpm

-- Max Curve --

Max power:
 12.1 hp @ 852 US gpm

--Additional Data--

Std. Shaft Diameter :1.5"
 Max. Shaft Diameter: C.F.
 Opt. Lateral Setting: 0.02
 Std. Lateral:0.54
 One Stage Subm. WT-LB:N/A
 One Stage Water Lub. WT-LB:272.2
 One Stage Oil Lub. WT-LB:272.8
 Add Stage WT-LB:100.1
 Impeller Weight:10 lb
 Min. Submergence:20

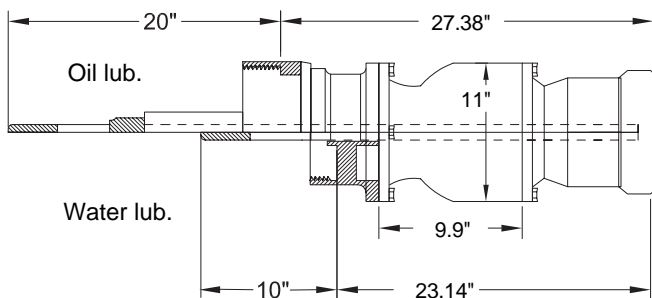
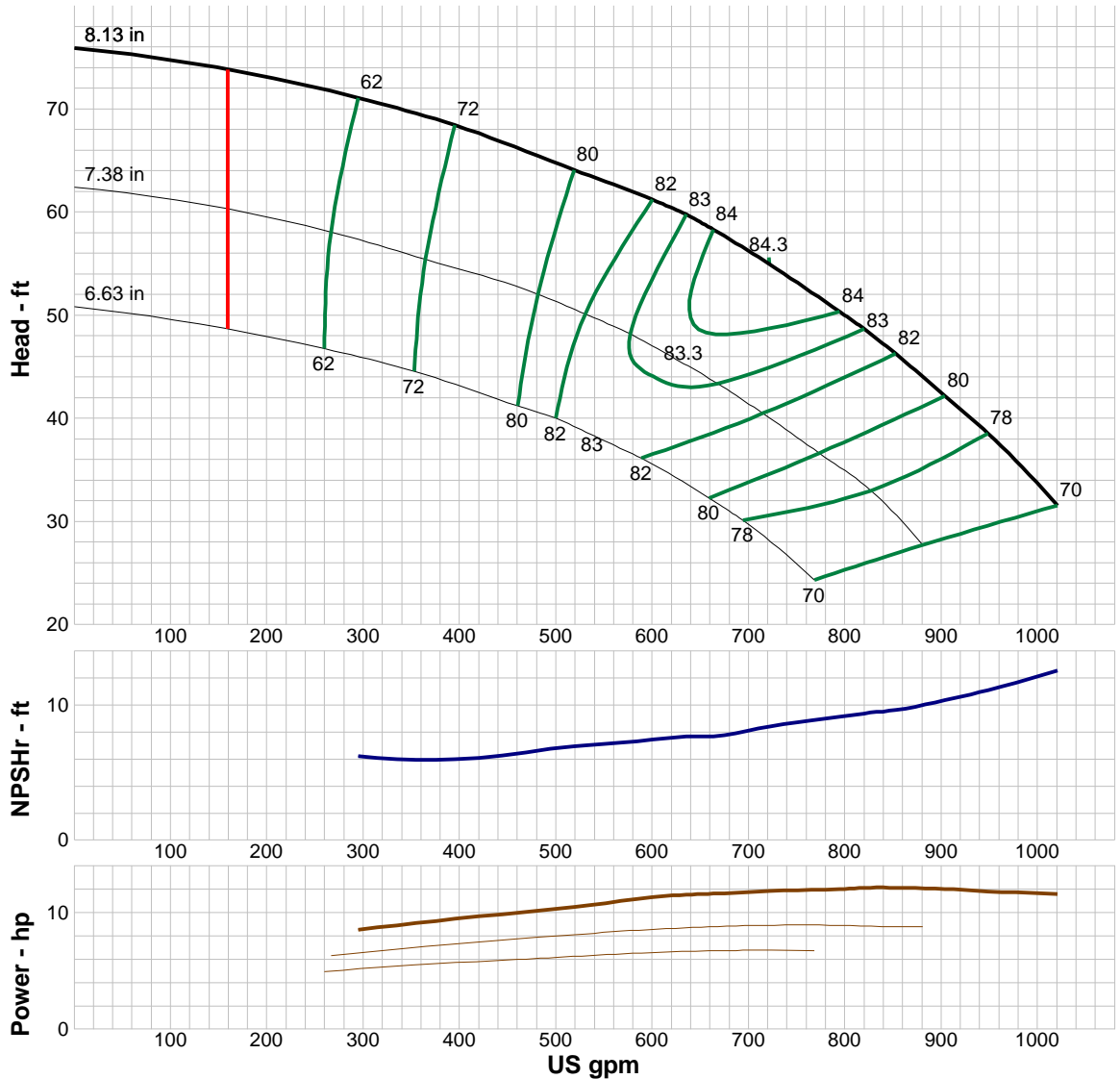

Performance Evaluation:

Flow US gpm	Speed rpm	Head ft	Efficiency %	Power hp	NPSHr ft
979	1770	35.5	74.5	11.7	11.7
816	1770	48.9	83.1	12.1	9.36
653	1770	58.8	83.6	11.6	7.68
490	1770	65.1	78.2	10.3	6.73
326	1770	70.2	65.2	8.82	6.14



Company: Empresas Suarez S.A. de C.V.

Name:

Date: 8/4/2017

Pump:

Size: 11WH-1A (1 stage)
 Type: LINEA SEMI-ABIERTA
 Synch speed: 1800 rpm
 Curve: ETWBEEG
 Specific Speeds:
 Dimensions:
 Vertical Turbine:
 Speed: 1770 rpm
 Dia: 8.13 in
 Impeller: 11WH-1A
 Ns: 2533
 Nss: 1958
 Suction: 8"
 Discharge: RI 8" RI10"
 Bowl size: 11 in
 Max lateral: ---
 Thrust K factor: 6.8 lb/ft

Search Criteria:

Flow: --- Head: ---

Fluid:

Water
 SG: 1
 Viscosity: 0.9946 cP
 NPSHa: ---
 Temperature: 68 °F
 Vapor pressure: 0.3391 psi a
 Atm pressure: 14.7 psi a

Motor:

Standard: NEMA
 Enclosure: TEFC
 Sizing criteria: Max Power on Design Curve
 Size: 25 hp
 Speed: 1800
 Frame: 284T

Pump Limits:

Temperature: 167 °F
 Pressure: 380 psi g
 Sphere size: 0.5 in
 Power: 192 hp
 Eye area: 15.6 in²

---- Data Point ----	
Flow:	945 US gpm
Head:	68.2 ft
Eff:	85.3%
Power:	19.1 hp
NPSHr:	6.82 ft
---- Design Curve ----	
Shutoff head:	80 ft
Shutoff dP:	34.6 psi
Min flow:	201 US gpm
BEP:	85.3% @ 945 US gpm
NOL power:	21.2 hp @ 1311 US gpm
-- Max Curve --	
Max power:	21.2 hp @ 1311 US gpm
--Additional Data--	
Std. Shaft Diameter :	1.5"
Max. Shaft Diameter:	C.F.
Opt. Lateral Setting:	0.02
Std. Lateral:	0.54
One Stage Subm. WT-LB:	N/A
One Stage Water Lub. WT-LB:	272.2
One Stage Oil Lub. WT-LB:	272.8
Add Stage WT-LB:	100.1
Impeller Weight:	10 lb
Min. Submergence:	20

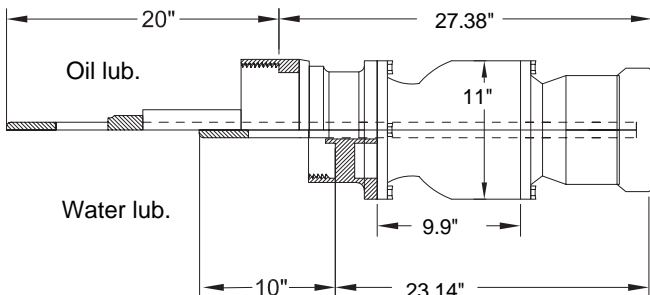
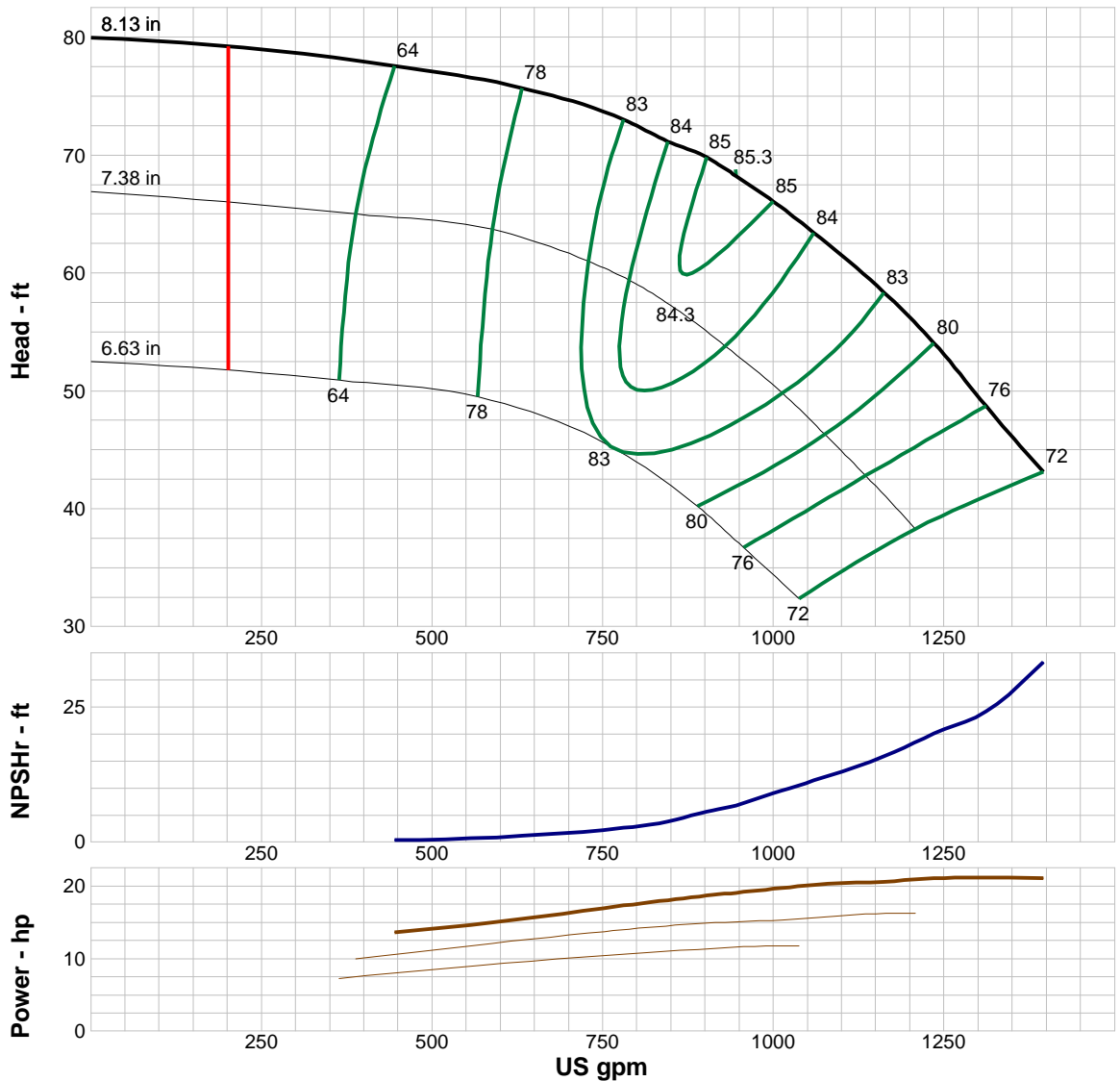

Performance Evaluation:

Flow US gpm	Speed rpm	Head ft	Efficiency %	Power hp	NPSHr ft
1339	1770	46.8	74.6	21.2	27.3
1116	1770	60.6	83.4	20.4	13.9
893	1770	70	84.8	18.6	5.39
670	1770	75	79.3	16	1.54
446	1770	77.5	64.1	13.6	0.388



Company: Empresas Suarez S.A. de C.V.

Name:

Date: 8/8/2017

Pump:

Size: 12Z-1A (1 stage)
 Type: LINEA SEMI-ABIERTA
 Synch speed: 1800 rpm
 Curve: ETZBDEH
 Specific Speeds:
 Dimensions:
 Vertical Turbine:
 Speed: 1760 rpm
 Dia: 9.375 in
 Impeller: 12Z-1A
 Ns: 2312
 Nss: 7580
 Suction: CB- 8"
 Discharge: RI8, RE 10"
 Bowl size: 11.3 in
 Max lateral: ---
 Thrust K factor: 12.5 lb/ft

Search Criteria:

Flow: --- Head: ---

Fluid:

Water
 SG: 1
 Viscosity: 0.9946 cP
 NPSHa: ---
 Temperature: 68 °F
 Vapor pressure: 0.3391 psi a
 Atm pressure: 14.7 psi a

Motor:

Standard: NEMA
 Enclosure: TEFC
 Sizing criteria: Max Power on Design Curve
 Size: 30 hp
 Speed: 1800
 Frame: 286T

Pump Limits:

Temperature: 167 °F
 Pressure: 584 psi g
 Sphere size: 0.625 in
 Power: 343 hp
 Eye area: 20.1 in²

---- Data Point ----

Flow: 1055 US gpm
 Head: 72.3 ft
 Eff: 82%
 Power: 23.5 hp
 NPSHr: 14.9 ft

---- Design Curve ----

Shutoff head: 90.5 ft
 Shutoff dP: 39.2 psi
 Min flow: 211 US gpm
 BEP: 82% @ 1055 US gpm
 NOL power:
 25.9 hp @ 1490 US gpm

-- Max Curve --

Max power:
 25.9 hp @ 1490 US gpm

--Additional Data--

Std. Shaft Diameter :1.5"
 Max. Shaft Diameter: C.F.
 Opt. Lateral Setting: 0.02
 Std. Lateral:0.30
 One Stage Subm. WT-LB:N/A
 One Stage Water Lub. WT-LB:241.9
 One Stage Oil Lub. WT-LB:263.1
 Add Stage WT-LB:120.6
 Impeller Weight:10 lb
 Min. Submergence:30

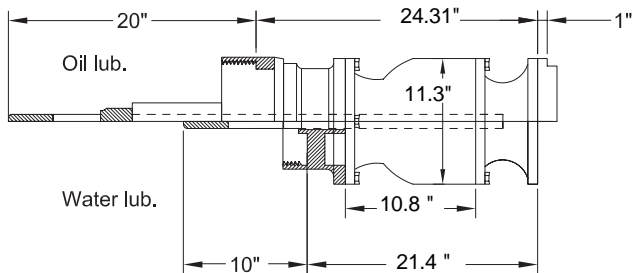
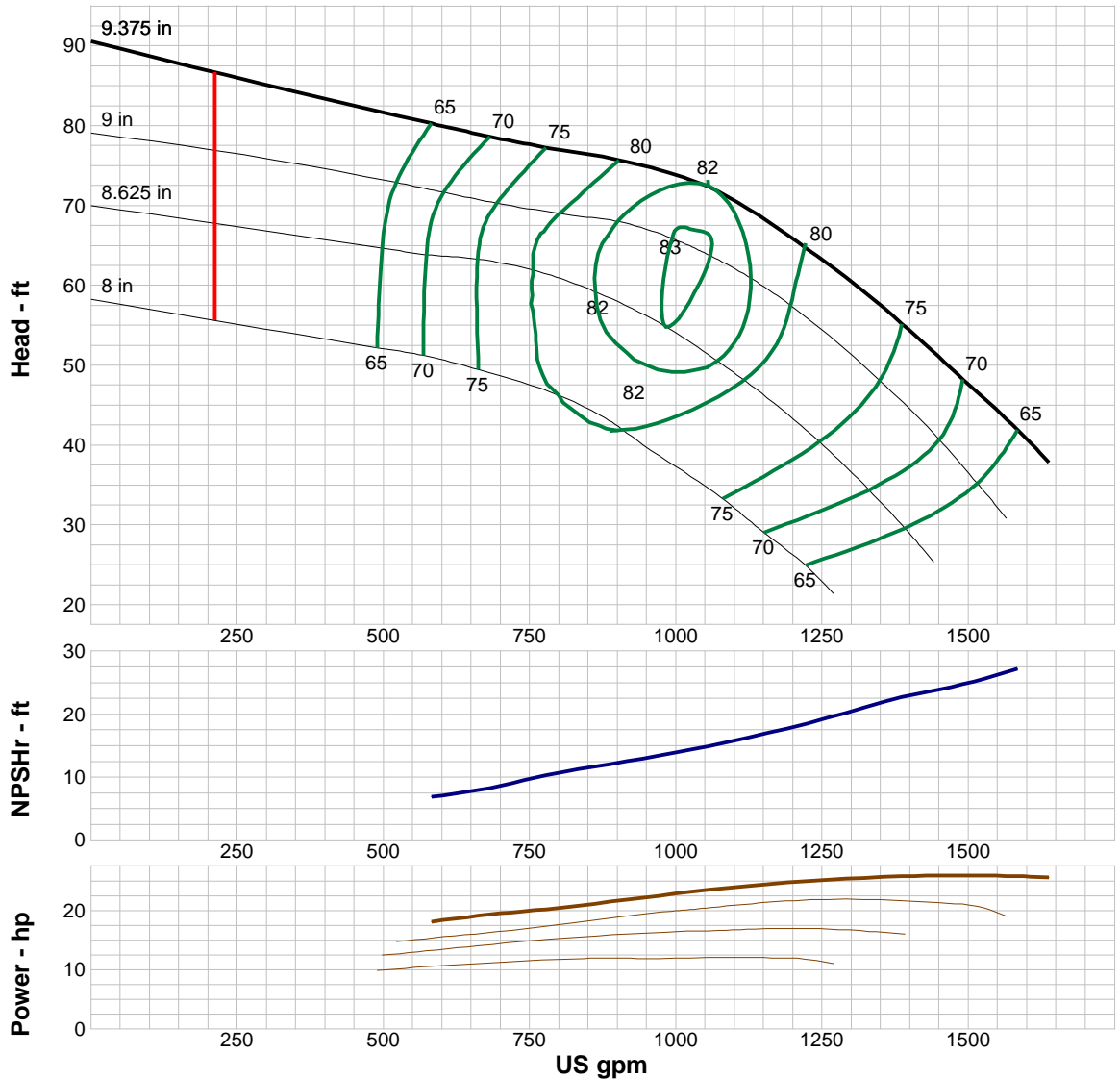

Performance Evaluation:

Flow US gpm	Speed rpm	Head ft	Efficiency %	Power hp	NPSHr ft
1572	1760	42.7	65.6	25.8	27
1310	1760	59.6	77.4	25.4	20.7
1048	1760	72.5	81.9	23.4	14.8
786	1760	77.2	75.3	20.3	10.5
524	1760	81.3	62.1	17.4	6.13



Company: Empresas Suarez S.A. de C.V.

Name:

Date: 8/7/2017

Pump:

Size: 12HXH-1A (1 stage)
 Type: LINEA SEMI-ABIERTA
 Synch speed: 1800 rpm
 Curve: ETXBDEH
 Specific Speeds:
 Dimensions:
 Vertical Turbine:
 Speed: 1785 rpm
 Dia: 9.47 in
 Impeller: 12HXH-1A
 Ns: 4469
 Nss: 7693
 Suction: 10"
 Discharge: RE 10" RI 12"
 Bowl size: 11.5 in
 Max lateral: ---
 Thrust K factor: 13 lb/ft

Search Criteria:

Flow: --- Head: ---

Fluid:

Water
 SG: 1
 Viscosity: 0.9946 cP
 NPSHa: ---
 Temperature: 68 °F
 Vapor pressure: 0.3391 psi a
 Atm pressure: 14.7 psi a

Motor:

Standard: NEMA
 Enclosure: TEFC
 Sizing criteria: Max Power on Design Curve
 Size: 30 hp
 Speed: 1800
 Frame: 286T

Pump Limits:

Temperature: 167 °F
 Pressure: 430 psi g
 Sphere size: 1.5 in
 Power: 429 hp
 Eye area: 32.8 in²

---- Data Point ----

Flow: 2114 US gpm
 Head: 39.2 ft
 Eff: 82.5%
 Power: 25.4 hp
 NPSHr: ---

---- Design Curve ----

Shutoff head: 74.2 ft
 Shutoff dP: 32.1 psi
 Min flow: 430 US gpm
 BEP: 82.5% @ 2114 US gpm
 NOL power:
 27 hp @ 430 US gpm

-- Max Curve --

Max power:
 27 hp @ 430 US gpm

--Additional Data--

Std. Shaft Diameter :1.94"
 Max. Shaft Diameter: C.F.
 Opt. Lateral Setting: 0.02
 Std. Lateral:0.68
 One Stage Subm. WT-LB:N/A
 One Stage Water Lub. WT-LB:255.5
 One Stage Oil Lub. WT-LB:255.5
 Add Stage WT-LB:123.1
 Impeller Weight:18.9 lb
 Min. Submergence:17

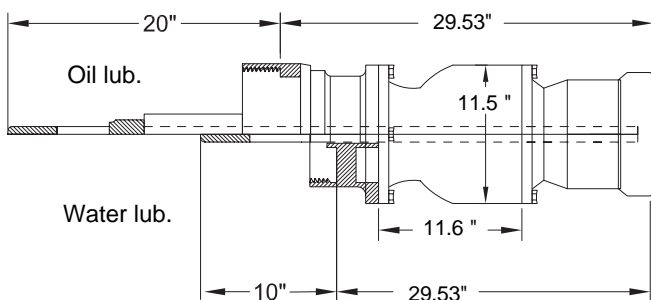
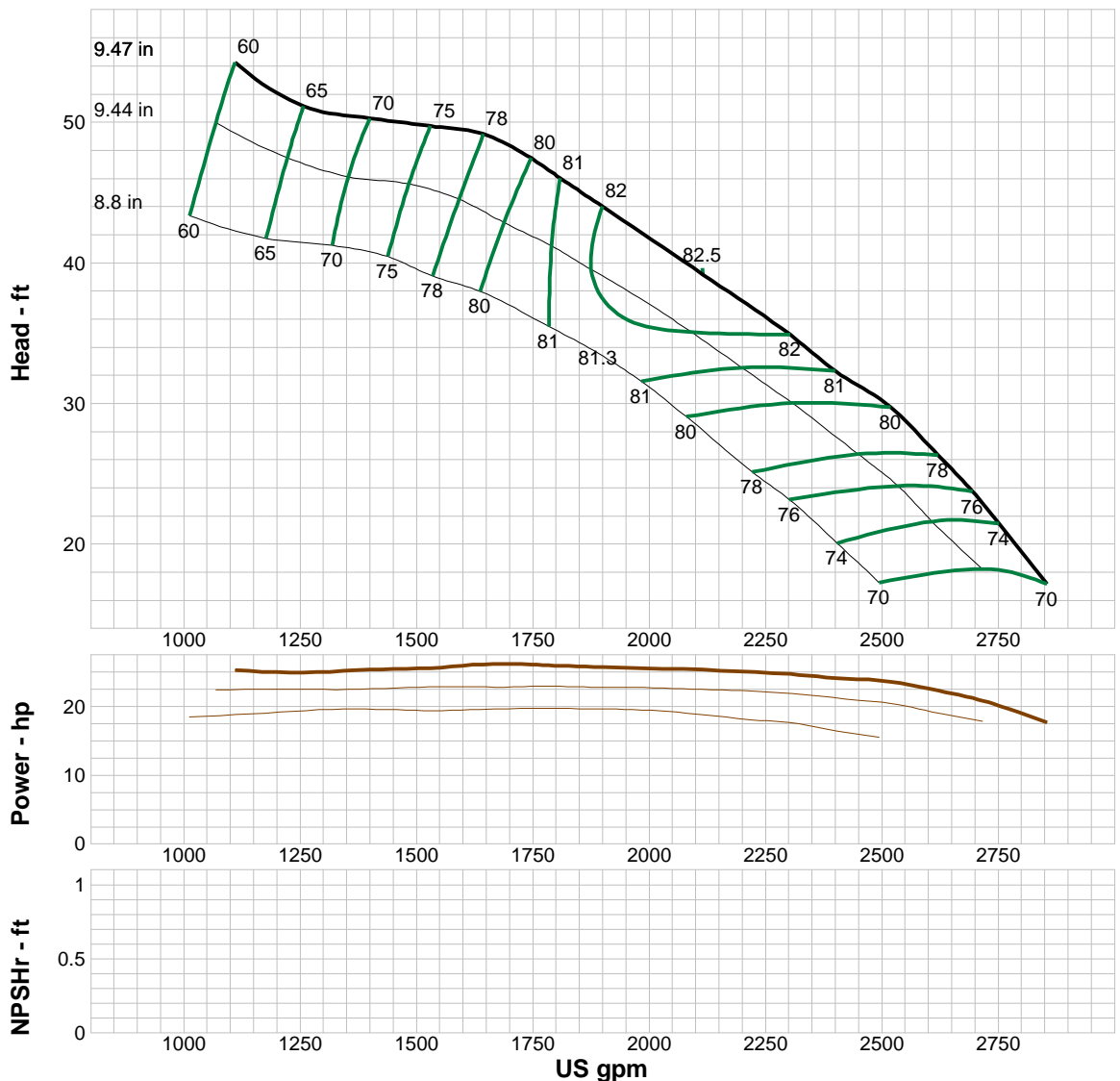

Performance Evaluation:

Flow US gpm	Speed rpm	Head ft	Efficiency %	Power hp	NPSHr ft
2740	1785	21.9	74.4	20.3	---
2283	1785	35.3	82.1	24.8	---
1826	1785	45.6	81.2	25.9	---
1370	1785	50.5	69	25.3	---
913	1785	58.4	53.4	25.8	---



Company: Empresas Suarez S.A. de C.V.

Name:

Date: 8/7/2017

Pump:

Size: 14HXH-1A (1 stage)
 Type: LINEA SEMI-ABIERTA
 Synch speed: 1800 rpm
 Curve: ETXBDEJ
 Specific Speeds:
 Dimensions:
 Vertical Turbine:
 Speed: 1760 rpm
 Dia: 11.813 in
 Impeller: 14HXH-1A
 Ns: 3997
 Nss: 8253
 Suction: CB- 12"
 Discharge: RI10", RI 12"
 Bowl size: 14.1 in
 Max lateral: ---
 Thrust K factor: 26.2 lb/ft

Search Criteria:

Flow: --- Head: ---

Fluid:

Water
 SG: 1
 Viscosity: 0.9946 cP
 NPSHa: ---
 Temperature: 68 °F
 Vapor pressure: 0.3391 psi a
 Atm pressure: 14.7 psi a

Motor:

Standard: NEMA
 Enclosure: TEFC
 Sizing criteria: Max Power on Design Curve
 Size: 75 hp
 Speed: 1800
 Frame: 365T

Pump Limits:

Temperature: 167 °F
 Pressure: 540 psi g
 Sphere size: 1.5 in
 Power: 422 hp
 Eye area: 47.3 in²

---- Data Point ----

Flow: 2840 US gpm
 Head: 73.5 ft
 Eff: 87.3%
 Power: 60.4 hp
 NPSHr: 23.5 ft

---- Design Curve ----

Shutoff head: 133 ft
 Shutoff dP: 57.4 psi
 Min flow: 595 US gpm
 BEP: 87.3% @ 2840 US gpm
 NOL power:
 60.6 hp @ 2694 US gpm

-- Max Curve --

Max power:
 60.6 hp @ 2694 US gpm

--Additional Data--

Std. Shaft Diameter :1.94"
 Max. Shaft Diameter: C.F.
 Opt. Lateral Setting: 0.02
 Std. Lateral:0.69
 One Stage Subm. WT-LB:N/A
 One Stage Water Lub. WT-LB:368.4
 One Stage Oil Lub. WT-LB:368.4
 Add Stage WT-LB:174.5
 Impeller Weight:23.3lb
 Min. Submergence:34

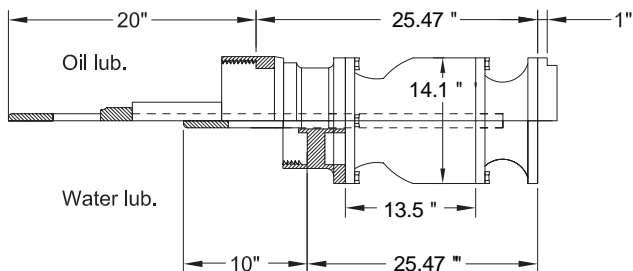
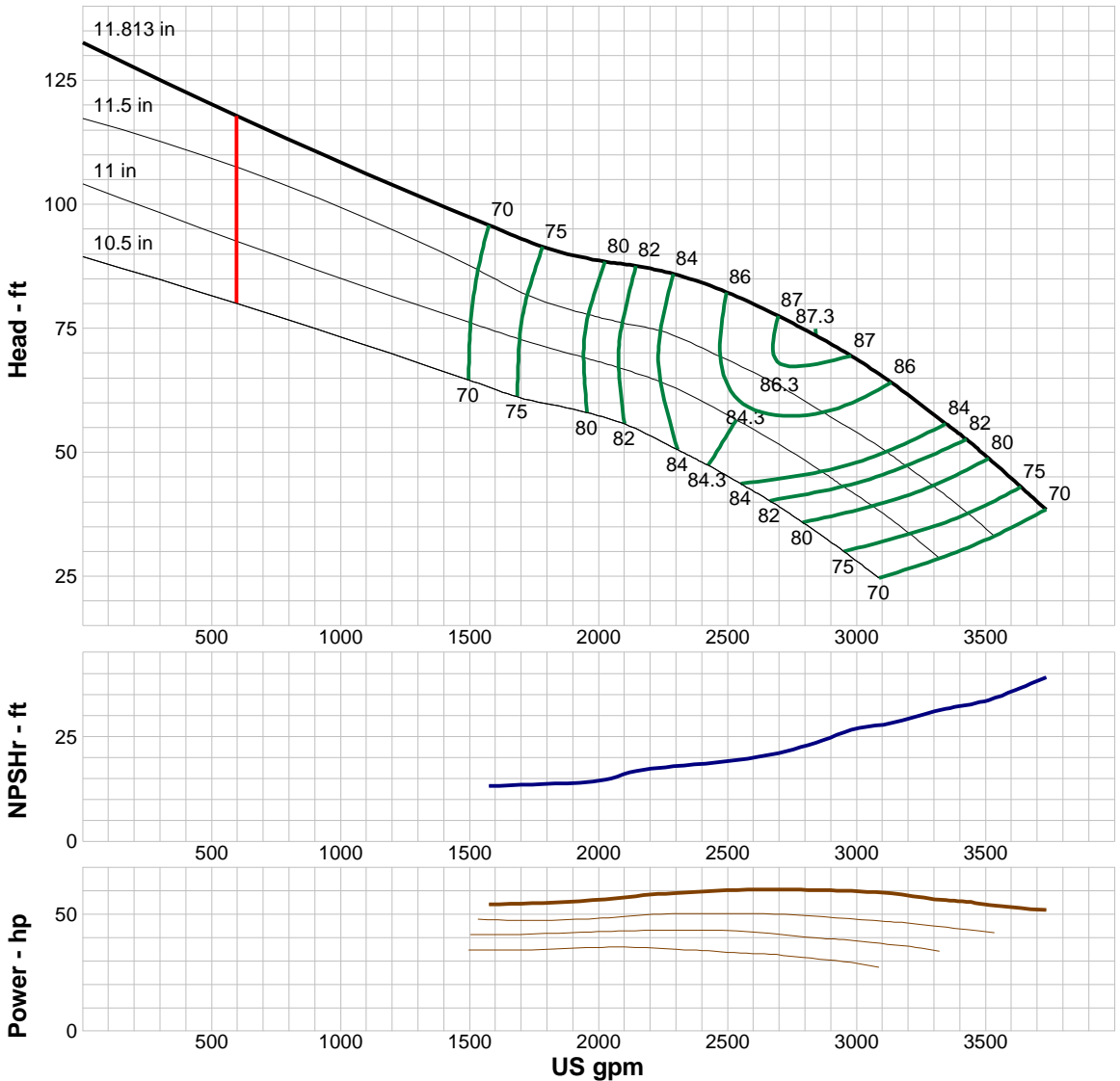

Performance Evaluation:

Flow US gpm	Speed rpm	Head ft	Efficiency %	Power hp	NPSHr ft
3583	1760	45.4	77.1	53.2	35.4
2986	1760	69.1	86.9	59.9	26.6
2389	1760	84.2	85	59.7	18.5
1792	1760	91.3	75.2	54.9	13.8
1194	1760	105	61	53.4	12.2



Company: Empresas Suarez S.A. de C.V.

Name:

Date: 8/7/2017

Pump:

Size: 14LS-1A (1 stage)
 Type: LINEA SEMI-ABIERTA
 Synch speed: 1800 rpm
 Curve: ETLBDEJ
 Specific Speeds:
 Dimensions:
 Vertical Turbine:
 Speed: 1760 rpm
 Dia: 11.313 in
 Impeller: 14LS-1A
 Ns: 2475
 Nss: 8105
 Suction: CB-10 "
 Discharge: RI 10"; RI 12"
 Bowl size: 13.7 in
 Max lateral: ---
 Thrust K factor: 19.7 lb/ft

Search Criteria:

Flow: --- Head: ---

Fluid:

Water
 SG: 1
 Viscosity: 0.9946 cP
 NPSHa: ---
 Temperature: 68 °F
 Vapor pressure: 0.3391 psi a
 Atm pressure: 14.7 psi a

Motor:

Standard: NEMA
 Enclosure: TEFC
 Sizing criteria: Max Power on Design Curve
 Size: 50 hp
 Speed: 1800
 Frame: 326T

Pump Limits:

Temperature: 167 °F
 Pressure: 540 psi g
 Sphere size: 0.75 in
 Power: 432 hp
 Eye area: 31.5 in²

---- Data Point ----	
Flow:	1690 US gpm
Head:	92.7 ft
Eff:	86%
Power:	46 hp
NPSHr:	18.3 ft
---- Design Curve ----	
Shutoff head:	130 ft
Shutoff dP:	56.2 psi
Min flow:	344 US gpm
BEP:	86% @ 1690 US gpm
NOL power:	48.8 hp @ 2193 US gpm
-- Max Curve --	
Max power:	48.8 hp @ 2193 US gpm
--Additional Data--	
Std. Shaft Diameter:	1.94"
Max. Shaft Diameter:	C.F.
Opt. Lateral Setting:	0.02
Std. Lateral:	0.25
One Stage Subm. WT-LB:	N/A
One Stage Water Lub. WT-LB:	354.6
One Stage Oil Lub. WT-LB:	354.6
Add Stage WT-LB:	177.8
Impeller Weight:	18.5 lb
Min. Submergence:	30

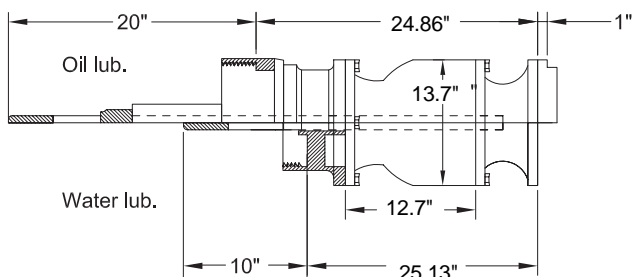
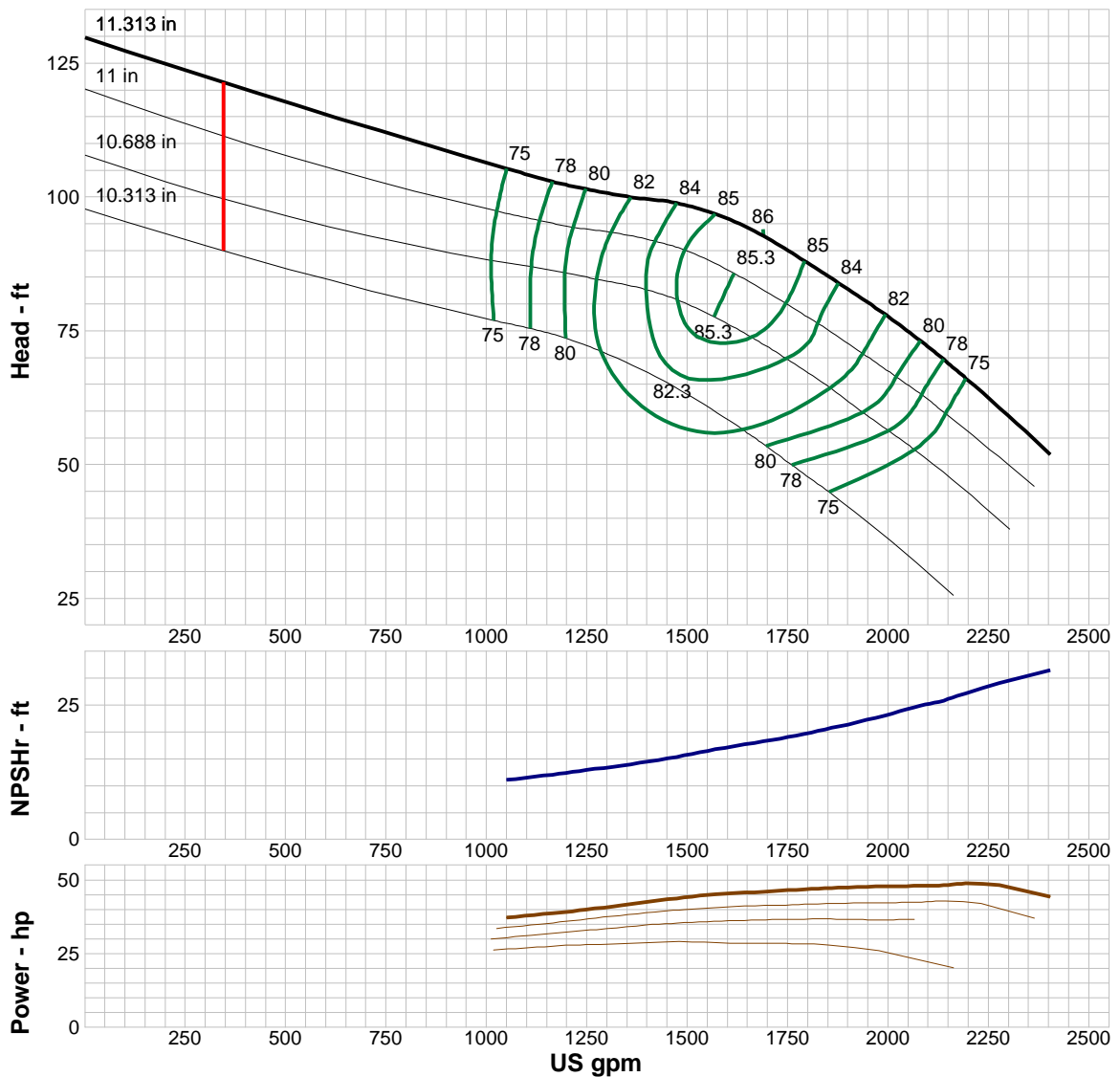

Performance Evaluation:

Flow US gpm	Speed rpm	Head ft	Efficiency %	Power hp	NPSHr ft
2306	1760	58.4	72.8	46.4	29.5
1922	1760	81.6	83.2	47.5	21.9
1538	1760	97.5	84.7	44.7	16.3
1153	1760	103	77.7	38.6	12
769	1760	112	67.6	33.5	8.72



Company: Empresas Suarez S.A. de C.V.

Name:

Date: 8/7/2017

Pump:

Size: 16MS-1A (1 stage)
 Type: LINEA SEMI-ABIERTA
 Synch speed: 1800 rpm
 Curve: ETMBDEL
 Specific Speeds:
 Dimensions:
 Vertical Turbine:
 Speed: 1770 rpm
 Dia: 13.187 in
 Impeller: 16MS-1A
 Ns: 3892
 Nss: 9156
 Suction: CB-12"
 Discharge: N/A
 Bowl size: 15.2 in
 Max lateral: ---
 Thrust K factor: 36 lb/ft

Search Criteria:

Flow: --- Head: ---

Fluid:

Water
 SG: 1
 Viscosity: 0.9946 cP
 NPSHa: ---
 Temperature: 68 °F
 Vapor pressure: 0.3391 psi a
 Atm pressure: 14.7 psi a

Motor:

Standard: NEMA
 Enclosure: TEFC
 Sizing criteria: Max Power on Design Curve
 Size: 200 hp
 Speed: 1800
 Frame: 447T

Pump Limits:

Temperature: 167 °F
 Pressure: 430 psi g
 Sphere size: 1 in
 Power: 792 hp
 Eye area: 78.6 in²

---- Data Point ----

Flow: 4339 US gpm
 Head: 103 ft
 Eff: 86.3%
 Power: 131 hp
 NPSHr: 27.4 ft

---- Design Curve ----

Shutoff head: 125 ft
 Shutoff dP: 54.2 psi
 Min flow: 926 US gpm
 BEP: 86.3% @ 4339 US gpm
 NOL power:
 186 hp @ 1476 US gpm

-- Max Curve --

Max power:
 186 hp @ 1476 US gpm

--Additional Data--

Std. Shaft Diameter :1.94"
 Max. Shaft Diameter: C.F.
 Opt. Lateral Setting: 0.02
 Std. Lateral:0.60
 One Stage Subm. WT-LB:N/A
 One Stage Water Lub. WT-LB:442.5
 One Stage Oil Lub. WT-LB:442.5
 Add Stage WT-LB:225.7
 Impeller Weight:34.4lb
 Min. Submergence:39

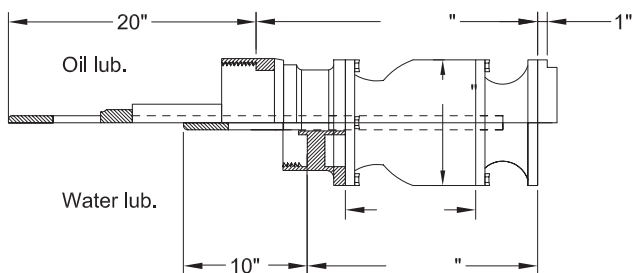
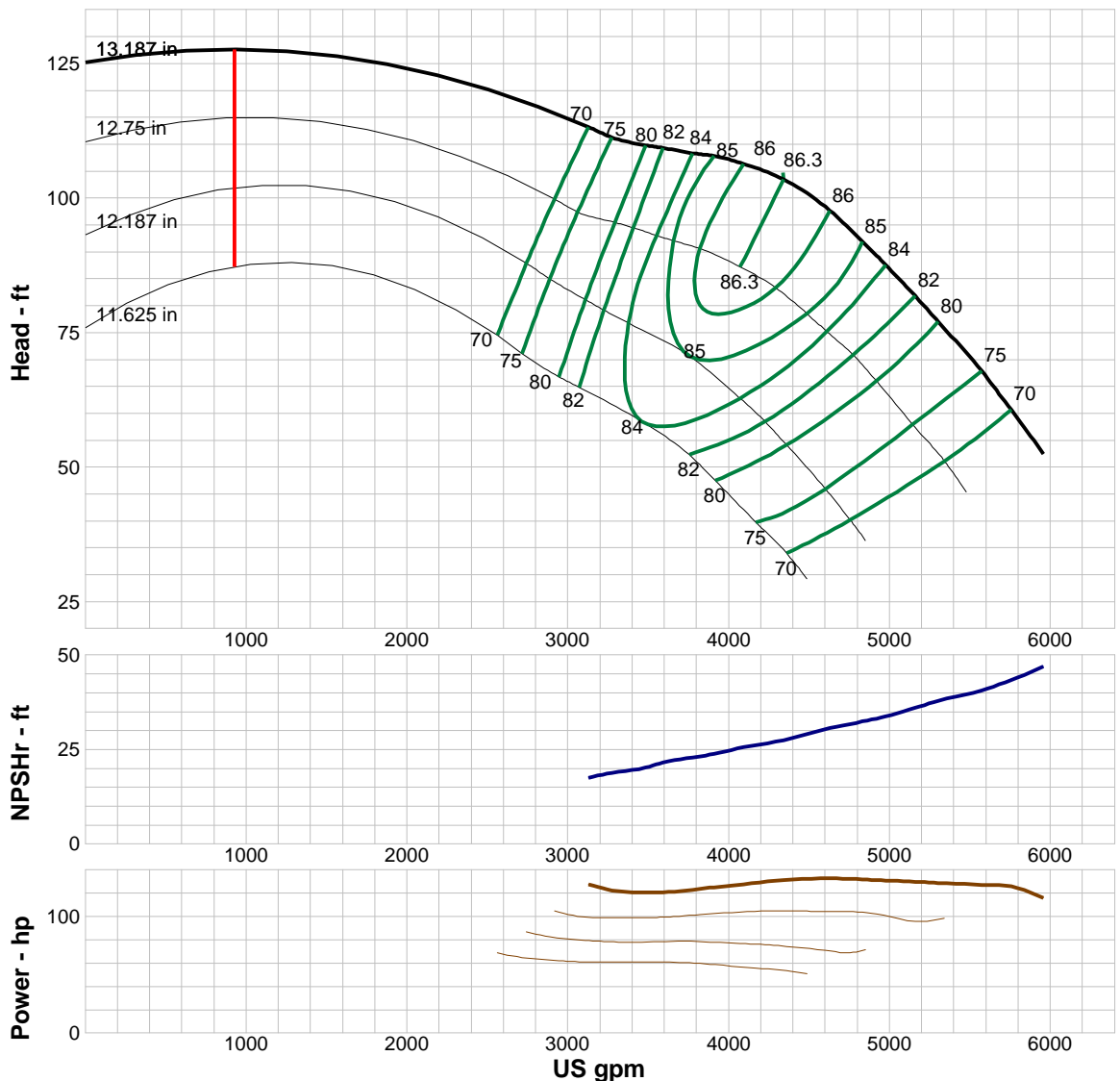

Performance Evaluation:

Flow US gpm	Speed rpm	Head ft	Efficiency %	Power hp	NPSHr ft
5717	1770	62.1	71	126	42.8
4764	1770	93.8	85.3	132	31.8
3811	1770	108	84.3	123	23.2
2858	1770	114	60.7	137	15
1906	1770	118	27.8	171	6.04